



## **ENGINEERED BEYOND THE GEARS™**

**TRANSMISSIONS TRANSFER CASES DIFFERENTIALS DRIVESHAFTS  
TORQUE CONVERTERS CLUTCHES ENGINES HARD PARTS OEM PARTS**

# NORTH AMERICAN POWERTRAIN COMPONENTS

## TABLE OF CONTENTS

Manufacture Lines .....	3
Warranties .....	4
Our Warehouse .....	5
Heavy Hauler Transmissions ...	6-18
Automatic Transmissions .....	19-20
Standard Transmissions .....	21
Allison Transmissions .....	22
Transfer Cases .....	23-24
Transfer Case Motors .....	24
Differentials .....	25
Dana Crate Axles .....	27
Hard Parts .....	28-30
Covers .....	30
Clutches .....	31
Torque Converters .....	32
NAPC Drive Shaft Balancer .....	33
Drive Shafts .....	34-35
Universal Joints .....	36
Yokes .....	37
Engines .....	38
Shipping .....	39
FAQ : Specing a Unit .....	40



### LEADING RE-MANUFACTURER IN POWERTRAIN

Being one of Canada's premier powertrain remanufacturers, North American Powertrain Components is your source for Transmissions, Differentials, Torque Converters, Drive Shafts, Engines and Hard Parts.

### SERVICE / KNOWLEDGE / SELECTION

A Quality Team working hard to earn your business

- New product updates
- Same day shipping
- Competitive pricing
- Very knowledgeable staff
- Over 500 product lines and growing

### Questions? call or email us

1.866.456.4498 or 780.456.4498

[info@napc.ca](mailto:info@napc.ca)

### Hours of Operation

We are open Monday thru Friday  
from 8:00am to 5:00pm

### Location

12836-151 Street  
Edmonton, Alberta, Canada  
T5V 1G8



























### Visit us online

[www.napc.ca](http://www.napc.ca)



# MANUFACTURE LINES

North American Powertrain Components is a proud dealer of the following industry suppliers. After building a strong reputation as one of Canada's premier powertrain manufacturers, NAPC was able to establish this trusted line of suppliers that are sure to exceed your expectations.

- |                                                                                     |                                                                                  |                                                                                      |                                                                |
|-------------------------------------------------------------------------------------|----------------------------------------------------------------------------------|--------------------------------------------------------------------------------------|----------------------------------------------------------------|
|    | <b>AISIN</b><br>Powertrain Parts                                                 |     | <b>LUK</b><br>Clutches, Flex Plates                            |
|    | <b>ALTO PRODUCTS</b><br>Frictions, Steels                                        |    | <b>MAGNA POWERTRAIN</b><br>Powertrain Parts, Transfer Cases    |
|    | <b>AMERICAN AXLE MANUFACTURING</b><br>Differentials Parts, Driveshafts, U-Joints |   | <b>MAG-HYTEC</b><br>Aftermarket Differential/Transmission Pans |
|   | <b>AUBURN GEAR</b><br>Posi, Gears & Components                                   |  | <b>MOTIVE GEAR</b><br>All Automotive Parts, Differential Parts |
|   | <b>BORG WARNER</b><br>Transfer Case Parts, Solenoids, Frictions                  |  | <b>PRECISION OF NEW HAMPTON</b><br>Torque Converters           |
|   | <b>DANA / EATON</b><br>Differential Parts, Transmissions Coolers                 |  | <b>RAYBESTOS POWERTRAIN</b><br>Frictions, Steels               |
|   | <b>DETROIT LOCKER</b><br>Differentials Parts                                     |  | <b>SONNAX</b><br>Valve Body Parts, Automatic Parts             |
|  | <b>DT COMPONENTS/TIMKEN</b><br>Bearings, Seals, Kits                             |  | <b>SOUTH BEND CLUTCH</b><br>OE & HD Clutches, Flex Plates      |
|   | <b>DYNATRAC</b><br>Free Spin Hub Kits, Ball Joints                               |  | <b>SPICER</b><br>Differential Parts, U-Joints                  |
|  | <b>FAG</b><br>Bearing Kits                                                       |  | <b>S-TEC</b><br>Transfer Cases, Transfer Case Parts            |
|  | <b>G2</b><br>Differentials                                                       |  | <b>TRANS-GO</b><br>Automatic Transmission Parts, Shift Kits    |
|   | <b>HEAVY HAULER</b><br>Transmissions                                             |  | <b>VALEO TRANSMISSION</b><br>Clutches, Fly Wheels              |
|   | <b>LUBEGARD</b><br>Automatic Transmissions Additives, Cleaners                   |   | <b>ZF &amp; ZF Life 2</b><br>Standard Transmission Parts       |



# INDUSTRY LEADING WARRANTY

**3 YEAR / 160,000KM** non-commercial

**3 YEAR / 100,000KM** on all Heavy Hauler Series

**3 YEAR / 100,000KM** on all commercial

We offer a vast coverage of warranty options throughout our remanufactured products. For more information about our warranty, visit us online or give us a call at

**780.456.4498** or **1.866.456.4498**



## GOING BEYOND THE COMPETITION

We are proud to introduce our latest piece of equipment at North American Powertrain Components (NAPC). The SuperFlow TransDyno SF-66K is state-of-the-art, built to NAPC specifications. This brand new model from SuperFlow tests our transmissions to NAPC's strict standards and is the only one of its kind in Canada.

The custom built electric motor delivers up to 700ft/lbs of torque to each unit during testing. It monitors and tests virtually every aspect of the transmission's performance under simulated road load conditions, including main pressure, eleven additional pressures, input/output speeds, input torque, output torque, PRNDL switches, fluid flow, pressure switches, and parking pawl.

Each unit is meticulously tested before it leaves our facility. The benefits of our high standards will be noticed immediately. Not only are you getting a unit that installs flawlessly, but you are getting peace of mind.





# OUR WAREHOUSE

Our large warehouse carries a wide variety of high quality transmissions, differentials, torque converters, transfer cases, engines, bearing kits, hard parts and more. We offer brand new O.E.M and replacement components, complemented with industry leading applications specific to your requirements.



## INVENTORY

We know that time plays a vital role in keeping customers satisfied and that is why NAPC keeps a large inventory level in stock and provides fast and convenient methods of shipping products safely to you on time.







## HEAVY HAULER® PERFORMANCE SERIES TRANSMISSIONS

The diesel performance market has grown rapidly over the past number of years and the demand for a reliable transmission has followed suit. Utilizing our vast experience and proven track record in the industry, we developed a product that is built to meet specific horsepower applications. Tested in-house to ensure unsurpassed quality, reliability, and peak performance.

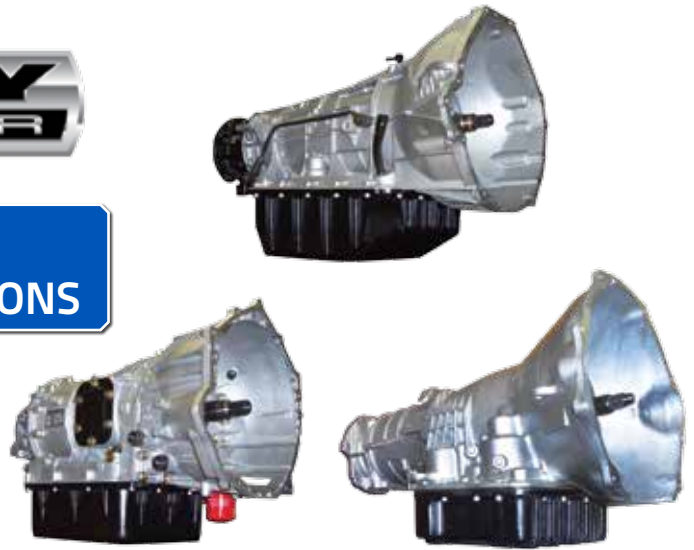

Countless hours of R&D have gone into each transmission and continue to go into every unit produced. With a solid reputation for durability and longevity, our Heavy Hauler® series heavy duty Allison 1000, E4OD, 46RE, 45/545RFE, 68RFE, 6L80/90, 4L80E, 4L65E, TH350/400, 4R70, 4R100, 5R110, 47RE/RH and 48RE are built with quality parts to tolerate extreme towing & racing performance loads.

Every transmission is built by North American Powertrain Components skilled technicians. Our technicians go through the units to find the weak links and enhance the strength and reliability where it's needed most. From standard parts upgrades to our proprietary additions, it's an exclusive combination that makes for one of the best heavy duty transmissions available.

Once completed, units are then put on our state-of-the-art Superflow TransDyno and load tested up to 700 foot-pounds of torque. We are the only manufacturer to have a Superflow TransDyno outfitted with a massive one-off custom electric motor to generate the torque loads we require for testing.

We take immense pride in our Heavy Hauler line of products and are confident in our final product. If you want to know more about what makes Heavy Hauler the top name when it comes to heavy duty transmissions, call one of our sales representative today, 1-866-456-4498!

# 46/47/48RE HEAVY HAULER



**NEW**

**46RE HD**  
**350 47/48 RE**  
**450 47/48 RE**  
**Full Race 47/48 RE**  
**BRX 47/48 RE**

## FEATURES

	46RE HD	350 47/48 RE	450 47/48 RE	Full Race 47/48 RE	BRX 47/48 RE
Overhaul kit with Gaskets and seals and Rings	■	■	■	■	■
Filter	■	■	■	■	■
Washers	■	■	■	■	■
Bushings	■	■	■	■	■
6 Clutch Front(High and Reverse) clutch pack for higher holding		■	■	■	■
5 Clutch Front(High and Reverse) clutch pack for higher holding	■				
5 Clutch Forward clutch pack for higher holding ability				■	■
6 Clutch OD clutch pack for higher holding ability		■	■	■	■
5 Clutch OD clutch pack for higher holding ability	■				
High ratio servo apply lever for high holding ability with quick release	■	■	■	■	■
Billet intermediate servo cover	■	■	■	■	■
Billet intermediate accumulator	■	■	■	■	■
Triple Disk NAPC Torque converter with FLS Lo Stall Stator			■	■	■
Single Billet NAPC Torque Converter	■	■			
Billet input shaft				■	■
Billet output shaft				■	■
New OE Governor solenoid	■	■	■	■	■
New OE Pressure Transducer	■	■	■	■	■
Billet intermediate shaft					■
Kolene Steels	■	■	■	■	■
NAPC Valve body with elevated oil pressure for more torque holding ability	■	■	■	■	■
<b>3 Year/100,000 KM Warranty</b>	■	■	■	■	■

## OPTIONAL

	46RE HD	350 47/48 RE	450 47/48 RE	Full Race 47/48 RE	BRX 47/48 RE
Mag Hytec Deep Pan	X	X	X	X	X
Mag Hytec Double Deep Pan	X	X	X	X	X
Billet input shaft			X		
Trans Brake with full manual VB (Race Only)					X
Full Manual VB (Race only)					X

## AVAILABLE

	46RE HD	350 47/48 RE	450 47/48 RE	Full Race 47/48 RE	BRX 47/48 RE
New OEM Trans Coolers 2003 Up		X	X	X	X
Inline Cooler Filter		X	X	X	X



# 45/545RFE/68RFE/65RFE HEAVY HAULER



*Built to handle Hemi & Cummins power*



**NEW**

65RFE HD/66RFE HD  
45/545RFE HD  
68RFE HD

### FEATURES

	65RFE HD/66RFE HD	45/545RFE HD	68RFE HD
Overhaul kit with Gaskets and seals and Rings	■	■	■
Filter	■	■	■
Washers	■	■	■
Bushings	■	■	■
Additional Under Drive Friction for higher holding ability	■	■	■
Additional Overdrive Friction for higher holding ability	■	■	■
New Pressure Transducer	■	■	■
NAPC Pressure Regulator Spring to achieve Higher Line			■
Machined UD pressure Plate for additional Friction	■	■	■
Machined OD pressure Plate for additional Friction	■	■	■
Single Billet NAPC Torque Converter	■	■	
Triple Disk NAPC Torque converter with FLS Lo Stall Stator			■
NAPC Valve body or new Chrysler with elevated oil pressure	■	■	■
<b>3 Year/100,000 KM Warranty</b>	■	■	■

### OPTIONAL

Mag Hytec Deep Pan	X	X	X
--------------------	---	---	---

### AVAILABLE

New OEM Trans Coolers 2003 Up			X
Inline Cooler Filter			X

# ALLISON 1000/LB7/LLY/LBZ HEAVY HAULER SERIES



*Handles the horsepower of your modified Duramax*



Full Race

## FEATURES

Triple Billet NAPC Torque converter	▪
Transgo Lockup Boost (Higher Lockup pressure)	▪
Extra Friction in C1 Clutch Pack (Forward)	▪
Extra Friction in C2 Clutch Pack (4Th)	▪
Extra Friction in C3 Clutch pack (3,5,R)	▪
NAPC Pressure Regulator Shim	▪
Transgo Shift Kit	▪
Pressure switch manifold	▪
Required A & B Trim solenoids	▪
Updated TCC F Trim solenoid	▪
E Shift valve Spring	▪
F Shift valve sleeve	▪
Internal and external filters	▪
Bushings	▪
Overhaul kit with sealing rings	▪
Molded Pistons	▪
Kolene Steels	▪
<b>3 Year/100,000 KM Warranty</b>	▪

## OPTIONAL

Mag Hytec Deep Pan (Requires Allison 2000 Deep Filter)	X
--------------------------------------------------------	---

# 6L80/90E HEAVY HAULER SERIES



*HD Performance & reliability for your Silverado, Corvette & Camaro*



## FEATURES

	6L80	6L90E
TECHM -Includes TCM (Trans Control Module) ,Solenoids, Pressure manifold	■	■
Filter	■	■
Overhaul Kit (Gaskets, Seals, Rings)	■	■
Trans Filter	■	■
Bonded Piston kit (All Clutch drum pistons)	■	■
Sonnax Zip Kit (VB repair)	■	■
Torque converter (New or NAPC Reman)	■	■
3 Alto Power pack clutch kits (Extra Friction and Steel) 4-5-6, 3-5-R, 2-6	■	■
Hi Energy Friction 2-6, L-R	■	■
1-Line pressure boost kit	■	■
Programing of TCM (We may require your ECM)	■	■
<b>3 Year/100,000 KM Warranty</b>	■	■

## OPTIONAL

Billet Intermediate shaft	X	X
Other Billet Parts TBA	X	X





*Based on the bullet proof TH400, this HD Transmission will get the job done*

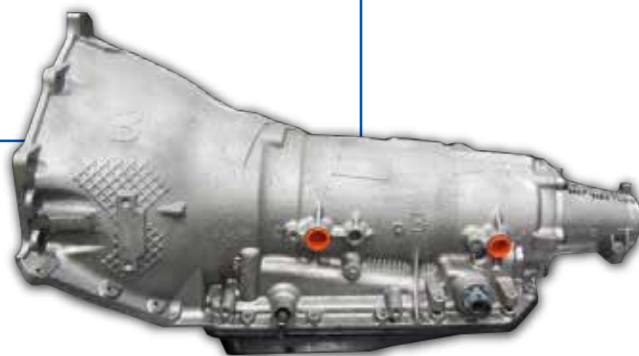

## FEATURES

	4L80E
Additional Direct Friction and steel for higher holding capacity	▪
Additional Intermediate Friction and steel for higher holding	▪
High Energy forward clutch pack	▪
High Energy Fourth clutch pack	▪
High Energy Intermediate Band	▪
Transgo/Superior HD Shift Kit	▪
New OE pressure control solenoid	▪
New Pressure Manifold	▪
New Shift Solenoids	▪
Overhaul kit with Gaskets Rings and seals	▪
Bushings	▪
Filter	▪
Washers/Bearings	▪
Kolene Steels	▪
HD Double Billet Converter (Billet Cover and Billet Piston)	▪
<b>3 Year/100,000 KM Warranty</b>	▪

# 700-4L65E HEAVY HAULER SERIES



*Firm shifts with reliability for your Chevy*



FEATURES			
	700	4L60E	4L65E
Additional 3-4 Friction and steel for higher holding capacity	■	■	■
Hardened sun shell	■	■	■
Transgo/Superior Shift kit	■	■	■
New OE pressure control solenoid		■	■
New Pressure Manifold		■	■
New Shift Solenoids		■	■
Corvette Intermediate servo For positive 1-2 /2-3	■	■	■
Borg Warner High energy Intermediate & 4th band	■	■	■
Oversize Boost valve	■	■	■
Overhaul kit with Rings and seals	■	■	■
Bushings	■	■	■
Filter	■	■	■
Washers/Bearings	■	■	■
Kolene Steels	■	■	■
HD Furnace Brazed Converter	■	■	■
<b>3 Year/100,000 KM Warranty</b>	■	■	■

## OPTIONAL

Painless 4th gear lockup Harness with Electrical unlocking at	X		
---------------------------------------------------------------	---	--	--

# 350/350C/400 HEAVY HAULER SERIES

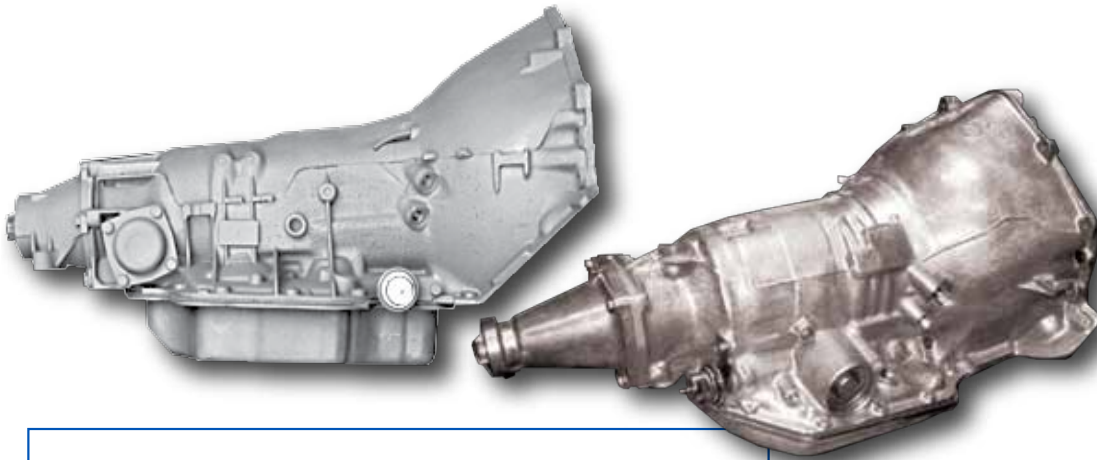

*These old timers can handle the horse power*

FEATURES	350	350C	400
Additional Direct Friction and steel for higher holding capacity	■	■	■
High Energy forward clutch pack	■	■	■
High Energy Intermediate Band	■	■	■
Transgo/Superior HD Shift Kit	■	■	■
Overhaul kit with Gaskets Rings and seals	■	■	■
Bushings/Bearings	■	■	■
Filter	■	■	■
Modulator	■	■	■
Washers/Bearings	■	■	■
Kolene Steels	■	■	■
Deep Factory Pan			■
<b>3 Year/100,000 KM Warranty</b>	■	■	■

OPTIONAL	350	350C	400
Cheater (No TCC Clutch) Converter		■	
Trans Brake (Race only) Other Mods Required	■		■
Custom Hi Stalls	■		■
Cast Aluminum Pan	■	■	■



# 5R110W HEAVY HAULER SERIES



*It handles Powerstroke power*



*Full Race*

## FEATURES

Overhaul kit with all gaskets and seals	■
Washers	■
Bushings	■
Trans Filter	■
Billet Input Shaft	■
Triple Billet NACP Torque converter	■
Additional Overdrive Friction for more holding Power	■
Additional Direct Friction for more holding power	■
Additional Forward friction for more holding power	■
Additional Intermediate friction for more holding power	■
Kolene Steels	■
Pump Reconditioned using Sonnax parts to like new spec	■
<b>3 Year/100,000 KM Warranty</b>	■

## OPTIONAL

Mag Hytec Deep Pan	X
Billet Intermediate shaft	X

## AVAILABLE

Inline Cooler Filter	X
----------------------	---

# E4OD/4R100 HEAVY HAULER SERIES



*Makes a good transmission even better for towing and hauling*

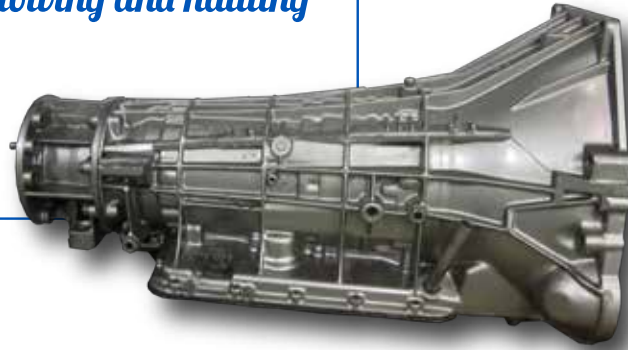

450 Series

## FEATURES

Overhaul gasket set with all rings and seals	▪
Washers	▪
Bushings	▪
Trans Filter	▪
Triple Billet NAPC Torque converter	▪
Additional Overdrive Friction for more holding Power	▪
Additional Direct Friction for more holding power	▪
Additional Forward friction for more holding power	▪
Additional Intermediate friction for more holding power	▪
New Solenoid Pack	▪
Transgo HD Shift Kit (Tugger)	▪
HD Intermediate sprag 45 Element	▪
Transgo On off Lockup kit	▪
Oversize line pressure modulator valve	▪
Kolene Steels	▪
<b>3 Year/100,000 KM Warranty</b>	▪

## OPTIONAL

Mag Hytec Deep Pan	X
Billet Input Shaft	X

## AVAILABLE

In Line Cooler Filter	X
-----------------------	---

# 4R70/4R75W HEAVY HAULER SERIES



*Heavy duty reliability and performance for your F150*



*HD Series*

## FEATURES

Overhaul kit with all gaskets and seals	▪
Washers	▪
Bushings	▪
Trans Filter	▪
Additional Reverse input friction for greater holding capacity	▪
Additional Direct friction for greater holding capacity	▪
Transgo HD shift kit with high pressure relief	▪
New OE pressure control solenoid	▪
Spiral Intermediate snap ring to reduce high RPM damage	▪
Sonnax Positive seal OD servo pin	▪
Kolene Steels	▪
HD Furnace Brazed Converter	▪
<b>3 Year/100,000 KM Warranty</b>	▪

## OPTIONAL

Mag HyTec/B&M cast pan	X
------------------------	---



# HH HEAVY HAULER



TRANSMISSIONS | TORQUE CONVERTERS | DIFFERENTIALS | DRIVESHAFTS | TRANSFER CASES



*Chrysler's Answer to the Allison*

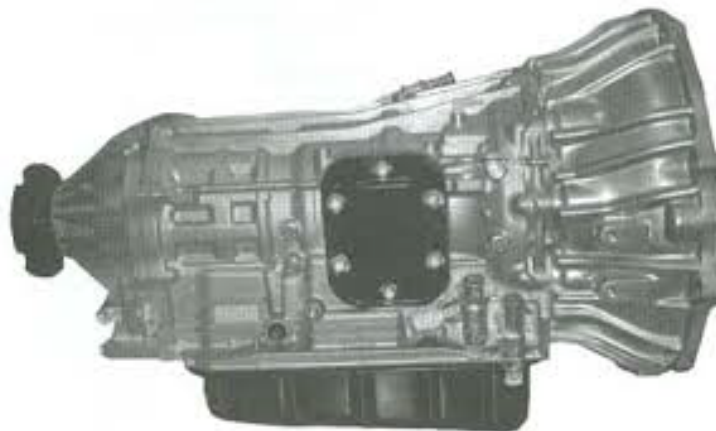

**FEATURES**

NAPC Torque converter with new captive clutch	▪
Internal filters	▪
Bushings	▪
Overhaul kit with sealing rings	▪
Molded Pistons	▪
All linear solenoids replaced with OE units	▪
Steels	▪
All friction replaced with Hi energy Friction	▪
All units are Dyno tested to verify Gear ratio, Trim (Linear) solenoid function, shift solenoid and pressure switch function.	▪
<b>3 Year/100,000 KM Warranty</b>	▪



# AUTOMATIC TRANSMISSIONS



The customer's need for reliability and longevity when purchasing a vehicle has placed greater demands on the auto industry. NAPC fully understands the necessity of creating products that have lasting power. North American Powertrain Components' focus on innovation has led to creating optimal transmissions and components. Our ATRA Certified technicians and staff attend conferences and seminars at ATRA, SEMA, AAPEX and others to stay on the forefront of new and innovative ideas.

We stock a complete inventory of Automatic Transmissions for Ford, Dodge/Jeep, GM front wheel and rear wheel drive vehicles. Each unit is built with quality and attention to detail and is 'showroom ready' because we want it to look as good on the outside as we know it is on the inside.

## FORD

<b>AX4S electric</b>	96-later 4 spd OD w/SK FWD
<b>AX4N electric</b>	95-later 4 sod OD FWD
<b>CD4E</b>	98 - up
<b>C6</b>	82-later 3 spd DIESEL w/SK & HD TC RWD/4WD
<b>4R70W electric</b>	98-04 4spd OD RWD/4WD
<b>4R75E electric</b>	2005-later 4 spd w/OD
<b>A4LD</b>	90-94 4spd OD 4.0L RWD/4WD
<b>4R44E electric</b>	95-96 4spd OD 3.0L RWD/4WD
<b>4R55E electric</b>	95-96 4spd OD 4.0L RWD/4WD
<b>5R44E electric</b>	97-99 5spd OD 3.0L RWD/4WD
<b>5R55E electric</b>	97-99 5spd OD 4.0L RWD/4WD
<b>E40D electric</b>	*89-94 4spd OD S/B & B/B RWD/4WD
<b>E40D electric</b>	*95-97 4spd OD S/B & B/B RWD/4WD
<b>E40D electric</b>	*97-98 4spd OD V10/Diesel 4WD
<b>4R100 electric</b>	*99-later 4 spd OD 5.4L RWD/4WD
<b>4R100 electric</b>	*99-later 4spd OD V10/DIESEL 4WD/RWD
<b>5R110 electric</b>	*03-06 5spd OD 6.0L DIESEL RWD/4WD
<b>5R110 electric</b>	*03-06 5spd OD 6.0L DIESEL w/PTO 4WD

## DODGE

<b>A727</b>	88-93 3spd Non-L/up DIESEL RWD/4WD
<b>A670</b>	87-94 3spd L/up 3.0L
<b>A670</b>	96-later 3spd L/up FWD
<b>A670</b>	96-later 3spd L/up 3.0L
<b>41TE electric</b>	96-later 4spd OD 4cyl FWD
<b>41TE electric</b>	96-later 4spd OD 2.5/3.0L FWD
<b>41TE electric</b>	96-later 4spd OD 3.3/3.8L FWD
<b>41TE electric</b>	01-later 4spd OD 3.3/3.8L FWD
<b>62TE</b>	2008-2010 Grand Caravan FWD
<b>42RH</b>	89-95 4spd OD L/up V6/V8 RWD/4WD
<b>42RE electric</b>	96-later 4spd OD V6/V8 RWD/4WD
<b>44RE electric</b>	95-later 4spd OD 4.0L Jeep 4WD
<b>46RH</b>	89-92 4spd OD non-l/up V8 RWD/4WD
<b>46RH</b>	92-95 4spd OD l/up V8 RWD/4WD
<b>46RE electric</b>	96-later 4spd OD V8 RWD/4WD
<b>47RH</b>	89-93 4spd OD non-l/up DIESEL RWD/4WD
<b>47RH</b>	94-95 4spd OD l/up V10/DIESEL RWD/4WD
<b>47RE</b>	03-04 2500-3500 4X4 DIESEL 5.9L
<b>47RE electric</b>	96-02 4spd OD V10/DIESEL RWD/4WD
 <b>48RE electric</b>	03-Up 4spd OD DIESEL RWD/4WD
 <b>48RE electric</b>	05-07 4spd OD Diesel RWD/4WD
<b>45REF/45RFE</b>	04-05 1/2 Ton GAS
<b>68RFE</b>	07-08 6 spd diesel
<b>AS 68RC</b>	2008 - 2010 3500, 4500, 5500 Cab & Chassis





# 48RE H.D Overdrive Housing

If you're in the industry, you already know cracks & breakage are a known problem with the 48RE Overdrive Housing. NAPC has addressed this issue and was able to create an 48RE overdrive housing that solves all the problems.



- **Designed & Machined Exclusively to NAPC**
- **North American Tried & Tested**
- **Accepts ALL O.D. Components**
- **Reinforced In The Area Prone To Cracking**
- **CNC Machined**
- **OEM Housings Are On B/O With All Dealerships**
- **Dealership Discounts Available**
- **Immediate Delivery**

To determine if your application meets specification for your truck, please relate to the following casting combinations.

<b>48RE Electric : 03-Up</b>
<b>09104 : 09104</b>
<b>48RE Electric : 05-07</b>
<b>44577 : 09104</b>

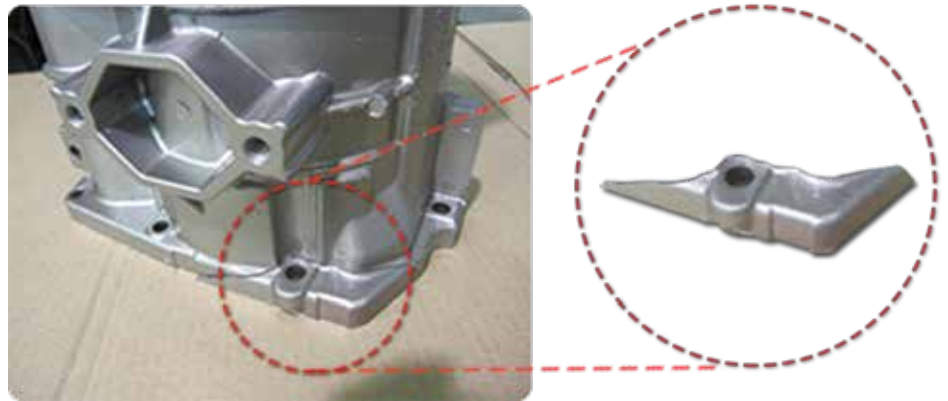

<b>GM</b>			
<b>4T60E electric</b>	92-98 4 spd FWD	<b>4L70E</b>	07 up Silverado / Envoy 4X2, 4X4 - 15 Pin
<b>4T65E electric</b>	98-later 4 spd FWD	<b>4L75E</b>	2009 - Up Silverado/Envoy 4X2, 4X4 - 17 Pin
<b>TH350C</b>	80-86 1/up 4WD	<b>4L80E electric</b>	91-94 4 spd OD RWD/4WD
<b>TH400</b>	76-later 4WD ALL	<b>4L80E electric</b>	95-96 4 spd OD RWD/4WD
<b>TH700R4</b>	82-86 4 spd OD 1/up RWD / 4WD	<b>4L80E electric</b>	97-later 4 spd OD RWD/4WD
<b>TH700R4</b>	87-92 4 spd OD 1/up RWD / 4WD	<b>4L80E electric</b>	99-up 7 Bolt Bell
<b>4L60E electric</b>	93-94 4 spd OD RWD / 4WD	<b>6L80E</b>	07 up Yukon & Denali
<b>4L60E electric</b>	1995 4 spd OD RWD / 4WD	<b>6L90E</b>	Call for more details
<b>4L60E electric</b>	96-97 4 spd OD RWD - 2 piece chassis	<b>Allison 1000</b>	2001-2005 Duramax 5 speed
<b>4L60E electric</b>	97-00 4 spd OD RWD/4WD	<b>Allison 1000</b>	2006-2008 Duramax 6 speed
<b>4L65E electric</b>	00-later 4 spd OD (rem B/H) RWD/4WD		

# STANDARD TRANSMISSIONS

The rigors that people put on their trucks range vastly - from daily driving, commuting or hauling loads . We understand the frustration that comes when a vehicle breaks down and we know that a road safe ride is of utmost importance. Our motto 'Engineered Beyond the Gears' speaks to the the high level of transmissions we produce. Our unparalleled upgrades and build procedures have lead to a high end product you can feel confident in.

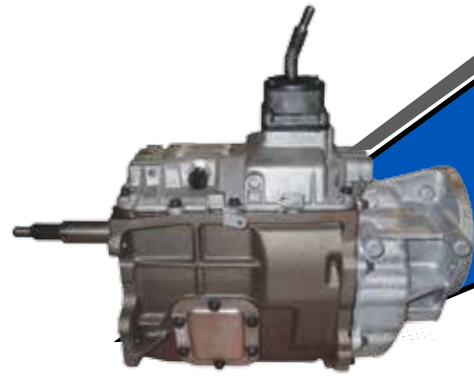

<b>FORD</b>	
ZF Small Block	5-spd, 302/351
ZF Small Block	5-spd, 96 and later
ZF Diesel	5-spd, Up to 95
ZF Diesel	5-spd, 96 and later
ZF V10	5-spd, 5.4L
ZF 6 Speed	7.3L 99-03 diesel
ZF 6 Speed	6.0L 03-07 diesel
F150 Mazda	5-spd, 5.0/5.8L (M5R2)
Mazda/Ranger/Explorer	5-spd, 2.9/3.0/4.0L (M5R1)
T5 Mustang	Call for more details

<b>DODGE</b>	
NV5600 6 Speed	99-05 diesel
G56 6 Speed	05 and later diesel
NV4500 5 SPEED	98-2002 RAM 4X4 DIESEL 5.9L
NV4500D	94-97 diesel/gas
NV4500D	98 and later diesel
NV4500D	Heavy Duty diesel
NV3500	94 and later gas
Getrag	4x4 diesel
Getrag	4x2 diesel
A535	Dakota gas
AX5	Call for more details
AX15	Call for more details
Peugot	Call for more details
GETRAG	2005-2009 DAKOTA 4X4
3550 5-SPEED	2002 - UP JEEP WRANGLER 4X4 4.0L



<b>GM</b>			
NV4500	Up to 95 diesel/gas	Getrag	88-94 gas
NV4500	96 and later diesel/gas	Getrag	95 and later gas
NV4500	HD E-Brake Style	ZF Diesel	2001-2009, 6.6 Diesel
NV4500	99 and later (new body style)	ZF Diesel	2005 - Up 6.6 Diesel Top Kick

# ALLISON MEDIUM / HEAVY DUTY TRANSMISSIONS

We know that a majority of today's fleets rely heavily on their service vehicles, therefore we now offer Allison medium to heavy duty transmissions for the construction, waste and other transportation fleets.

## Transmission

AT 542 / 545 SERIES

MT 643 / 653 SERIES

MT 644 / 654 SERIES

HT 740 SERIES - TRANSIT

HT 740 '777' SERIES - WASTE

HT 741 - 748 - TRANSIT

HT 750 / 754 SERIES

HT 750 DRD

MD 3060 / 3560P SERIES

HD 4060 / 4560P / 4500RDS

2400 / 2500 SERIES

B300 / B300R

B400 / B400R

B500 / B500R



All Allison transmissions comes with a 3 Year / 60,000 KM warranty.



# TRANSFER CASES

The sales of 4 wheel drive vehicles has brought more attention to requiring solid performing transfer cases. We understand the demands that need to be met are paramount. That is why we remanufacture each unit with a process like no other.

## FORD

<b>1356</b>	87-96 F-150 Electric Shift
<b>1356</b>	87-96 F-150 Manual Shift
<b>271F</b>	99-07 F-250 Manual Shift
<b>273F</b>	99-07 F-250 Electric Shift
<b>273F</b>	08-10 F-250/F-350 Electric Shift
<b>4404</b>	96-01 Explorer Viscous Drive
<b>4405</b>	95-01 Explorer
<b>4406</b>	96-06 Manual Shift
<b>4406</b>	96-06 F-150 TOD Electric Shift
<b>4407</b>	94-97 F-350 Manual Shift
<b>4407</b>	94-97 F-350 PTO Manual Shift
<b>4410</b>	02-04 Explorer AWD
<b>4411</b>	02-05 Explorer Electric Shift
<b>4412</b>	07-09 Explorer
<b>4416</b>	02-05 Expedition
<b>4419</b>	09-10 F-150

## DODGE

<b>205 D</b>	88-93 Dodge 2500
<b>231 D</b>	88-99 Dakota/Dodge 1500
<b>231 D</b>	1993 ONLY Dakota
<b>231 J</b>	89-01 Jeep Cherokee
<b>241 D</b>	02-06 Dodge 1/2 Ton
<b>241 DLD</b>	94-02 Dodge 2500
<b>241 DHD</b>	94-02 Dodge 3500
<b>242 J</b>	89-01 Grand Cherokee
<b>243 D</b>	02-05 & 06-08 Dodge 1500 Electric Shift
<b>244 D</b>	01-05 Dodge 1500/Durango
<b>246 D</b>	06-Up Dodge 1500 Electric Shift
<b>247 J</b>	99-04 Grand Cherokee
<b>249 J</b>	93-95 Grand Cherokee
<b>271 D</b>	03-Up Ram 2500 Manual Shift
<b>271 D</b>	2007-2010 3500/4500/5500 Cab & Chassis
<b>273 D</b>	2003-2005 2500/3500 Electric Shift
<b>273 D</b>	2006 Ram 3500 Electric Shift
<b>273 D</b>	2007-2010 3500/4500/5500 Cab & Chassis



We stock a complete inventory of transfer cases for Ford, Dodge/Jeep, GM light to heavy duty vehicles. All units are assembled with quality parts from reputable names like American Axle, Sonnax, Spicer New Process, Borg Warner, ALTO, DT Components, etc. We also make these quality parts available to you for purchase.

# TRANSFER CASES

## GM

<b>126</b>	02-03 Trailblazer/Envoy	<b>4401</b>	88-99 Chevy Truck
<b>136C</b>	99-02 Astro/Safari	<b>4470</b>	88-99 Chevy truck
<b>149</b>	02-05 Escalade/Yukon/Denali	<b>4472</b>	Astro Van
<b>208 C</b>	81-87 Chevy Truck	<b>4473</b>	Savana Van
<b>226</b>	02-03 Trailblazer/Envoy	<b>4474</b>	H2 Hummer
<b>233C</b>	92-94 S10/Sonoma	<b>4481</b>	2003-2006 Escalade
<b>236</b>	99-01 Blazer/S10/Envoy	<b>4482</b>	2003-2005 Tahoe/Yukon
<b>241 C</b>	90-91 Blazer/Suburban	<b>4484</b>	2003-2007 H2 Hummer
<b>243</b>	96-99 Chevy Truck	<b>4493</b>	2006-2007 H3 Hummer
<b>246 Early</b>	99-02 Chev Truck	<b>4494</b>	2006-2007 H3 Hummer
<b>246 Late</b>	03-07 Chev Truck	<b>273C</b>	Topkick
<b>261HD</b>	Chevy Truck 4L60/4L80	<b>Magna NQG</b>	07 up New Silverado - Manual Shift
<b>261XHD</b>	Chevy Truck Allison/Standard	<b>Magna NQH</b>	07-Up silverado Active
<b>263HD</b>	Chevy Truck 4L60/4L80	<b>Magna NQF</b>	07 up New W/ Motor - Silverado Electric
<b>263XHD</b>	Chevy Truck Allison/Standard		

# TRANSFER CASE MOTORS

<b>420-1133</b>	03-06 Dodge 2500 - 273 T-Case	<b>420-1263</b>	01-02 Chevy Truck - 263 T-Case New OE
<b>420-1226</b>	02-05 Envoy/Trailblazer	<b>420-2237</b>	03-07 Chevy Truck - 246 T-Case w/Torx Drive New OE
<b>420-1233</b>	94-02 Blazer/Sonoma	<b>420-2263</b>	03-07 Chevy Truck - 263 T-Case w/dowel New OE
<b>420-1235</b>	99-05 Astro/Safari	<b>420-4350</b>	86-95 Explorer
<b>420-1237</b>	99-02 Chevy 1/2 Ton - 246/236 T-Case	<b>420-4354</b>	95-04 Explorer - 1354 T-Case
<b>420-1243</b>	95-00 Chevy Truck - 243 T-Case		



# FRONT & REAR DIFFERENTIALS

There is no margin for error when it comes to differentials. RWD & 4WD vehicles depend on a reliable unit to get the power to the pavement. We understand that dependability is of utmost importance. That is why we remanufacture each unit with a process like no other.

We stock a complete inventory of front & rear differentials for Ford, Dodge/Jeep, GM 1/2 ton to 1 ton vehicles. All units are assembled with quality parts from reputable names like AAM, Spicer, Auburn Gear, Dana, DT Components, Motive Gear, Timken Bearings and more. We also make these quality parts available for you to order.

FORD	
REAR	99-03 F-150 8.8 POSI 3.55
REAR	04-08 F-150 8.8 POSI 3.55
REAR	99-04 9.75, 3.55, 3.73
REAR	05-08 9.75, 3.55, 3.73
REAR	99-01 10.5
REAR	02-04 10.5
REAR	E-350 Dana 70 4.10
REAR	F-450 Dana 80 4.10/4.88
REAR	01-04 F-550 S/D 14.25 (Carrier Only)
REAR	05-08 F-550 S/D 14.25 (Carrier Only)

DODGE	
REAR	94-99 9.25
FRONT	03-08 AAM 9.25
FRONT	94-97 3/4-1 ton Dana 60 3.54 (no spindles/axles)
REAR	00-01 9.25
REAR	02-05 9.25
REAR	94-00 3/4-1 ton Dana 80 single wheel POSI 3.54 (no brakes/axles)
REAR	01-02 3/4-1 ton Dana 80 single wheel POSI 3.54 (no brakes/axles)
REAR	03-08 AAM 11.5 Single Rear Wheel
REAR	03-08 AAM 11.5 Dual Rear Wheel

GM	
FRONT	99-02 7.25 IFS Astro Van/Safari 3.42/3.73
FRONT	03-05 7.25 IFS Astro Van/Safari 3.42/3.73
FRONT	Reman 99-04 8.25 IFS 1500 3.73
FRONT	Reman 99-04 8.25 IFS 1500 4.10
FRONT	NEW 2007-2010 1500 8.25
FRONT	NEW 99-2009 9.25 IFS 2500 3.73, 4.10
REAR	NEW 99-04 8.6 1500 POSI 3.73, 4.10
REAR	NEW 00-04 8.6 373/410 Active Brake
REAR	00-04 8.6 373/410 Drum Brake
REAR	NEW 99-04 10.5 2500 POSI
REAR	NEW 00-07 11.5 2500 POSI 3.73
REAR	NEW 09-11 & 11.5 2500 Active Brake
DUALLY P/U	NEW 00-07 11.5 3500 POSI 3.73

SPICER	
REAR	S135
REAR	S110





# INTRODUCING...

## NORTH AMERICAN **OFF-ROAD**



## GET ROCKY MOUNTAIN READY

NORTH AMERICAN OFF-ROAD IS THE SOURCE FOR G2 AXLE & GEAR  
AXLE ASSEMBLIES | DIFFERENTIAL COVERS | RING & PINIONS



### WHAT MAKES CORE 44 AXLE ASSEMBLIES THE ONLY CHOICE

- Heavy duty 3" x 5/16" DOM tubes to resist bending
- 1/4" Laser cut heavy duty brackets designed around factory mounting points
- Massive forged inner C-ends for added strength
- Utilizes the latest generation of Dana 44 ring and pinions with stronger pinion shaft
- Compatible with factory JK Tru-Lok® locker or conventional aftermarket lockers



**CORE 44**

**AUTHORIZED DEALER!**

A PROUD PART OF



12836-151 STREET, EDMONTON, AB • 866.456.4498 • INFO@NAPC.CA • NAPC.CA





# 30



DANA MODEL	RING GEAR SIZE (IN/MM)	LOCATION	TORQUE LIMIT @ INPUT (FT.-LBS.)	GAWR (LBS.)	GVW (LBS.)	GCW (LBS.)
30	7.30 / 186	FRONT	1450	3080	5700	8000

# 44



DANA MODEL	RING GEAR SIZE (IN/MM)	LOCATION	TORQUE LIMIT @ INPUT (FT.-LBS.)	GAWR (LBS.)	GVW (LBS.)	GCW (LBS.)
44	8.90 / 226	REAR	1930	4080	5700	8500
44	8.50 / 216	FRONT	1930	3360	5700	8000

# 60



DANA MODEL	RING GEAR SIZE (IN/MM)	LOCATION	TORQUE LIMIT @ INPUT (FT.-LBS.)	GAWR (LBS.)	GVW (LBS.)	GCW (LBS.)
60	9.75 / 248	REAR	2400	5760	8200	17100
60	10.10 / 256	FRONT	2748	7350	16000	30000

# 70



DANA MODEL	RING GEAR SIZE (IN/MM)	LOCATION	TORQUE LIMIT @ INPUT (FT.-LBS.)	GAWR (LBS.)	GVW (LBS.)	GCW (LBS.)
70	10.50 / 267	REAR	2600	8580	9900	18000
70	10.75 / 273	FRONT	3450	8400	19500	26000

# 80



DANA MODEL	RING GEAR SIZE (IN/MM)	LOCATION	TORQUE LIMIT @ INPUT (FT.-LBS.)	GAWR (LBS.)	GVW (LBS.)	GCW (LBS.)
80	11.25	REAR	3000	10100	14000	30000

## HARD PARTS

When we are building your industry leading NAPC unit, we only use the most trusted supplier brands such as Timken, American Axle, Auburn Gear, Eaton, etc. Using these products allows us to produce a RELIABLE, EFFICIENT, HIGH-PERFORMANCE and DURABLE remanufactured product offering quality and satisfaction for our customers.

We guarantee that all parts, such as gears, shafts, crown and pinions, bearings, frictions and more are competitive with today's market pricing. Without having to worry about your product failing, we also offer a 3 Year / 160,000KM warranty on all re-manufactured parts. For more details regarding our warranty, please call 1-866-456-4498.

With so many hard parts, NAPC houses over an extensive line of inventory and a wide range of applications available for Ford, Dodge/Jeep and GM.



## LIMITED-SLIP DIFFERENTIALS

Starting from a quality viable differential, we are able to make high performance improvements by attaching premium parts from Auburn Gear, American Axle and Eaton limited slip. Allowing better stability, durability, reliability for your light and heavy duty applications.



## CROWN & PINIONS

We stock and sell an abundance of high quality crown & pinions from AAM, Spicer and Motive Gear for your applications.



# BEARING KITS

Next time you need to overhaul an existing unit, give us a call. We carry top of the line bearing & seal kits featuring DT Components and FAG bearings and quality seals. We use them for all of our remanufactured units.

Available for:

- Differential Assembly
- Axle Assembly
- Transfer Cases
- Standard Transmissions
- Individual Bearing and Seals



# AXLE SHAFTS

We sell high quality remanufactured axle shafts for your Dodge, Ford and GM applications supplied from our trusted lines; American Axle and Spicer.

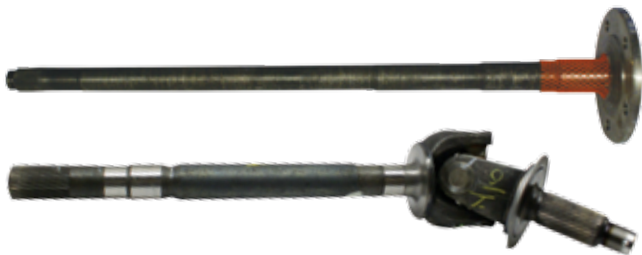

## FORD

**40003204** ..... OEM AXLE SHAFT - FORD 8.8 RIGHT REAR EXPLORER / MOUNTAINEER

## DODGE

**5086984AB** ..... OEM AXLE SHAFT - AAM 11.5 03-04 P/U DRW 1 TON LH/RH

**40022279** ..... A/M AXLE SHAFT - DODGE 11.5 RH REAR

**40020734** ..... OEM SHAFT ASSEMBLY - DODGE 9.25 LH SIDE SHORT 03-10

**40020735** ..... OEM SHAFT ASSEMBLY - DODGE 9.25 RH SIDE LONG

**DPD44AXL0011** ..... 99-01 DODGE 1500 RH FRONT AXLE

**DPD44AXL0012** ..... 99-01 DODGE 1500 LH FRONT AXLE

## GM

**40003204** ..... OEM - AXLE SHAFT - AAM 11.5 - L/R DRW C&C 30SPL

**DPG85AXL0006** ..... SPICER - AXLE SHAFT - GM 8.5 FRONT - RH INNER



# BALL JOINT/STUD KITS

We supply quality American Axle ball joint kits with longer lifespan and dispersed lubrication offering balance and suspension for your truck. These kits are made from the highest quality raw materials and engineered for reliability.

When ordering through us use the following part number.

## Part#

**74100001** ..... 03 - up 9.25" Front Beam / Chrysler



# DIFFERENTIAL COVERS & TRANSMISSION PANS

In addition to our remanufactured differentials and transmissions, we also stock the following differential covers and transmission pans for your heavy duty applications; American Axle, MAG-HYTEC and AFE Power. All differential covers and pans increase oil capacity, have cooling fins and come complete with a magnetic plug.

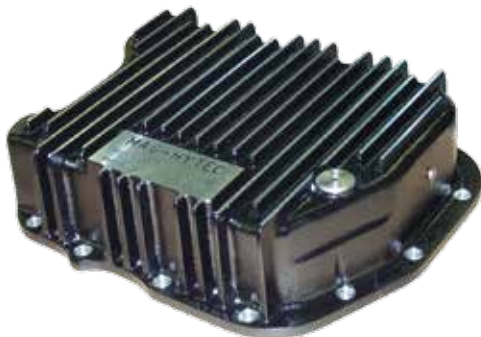



# CLUTCHES

Customized for your driving style, we sell a clutch that will suit your needs. From OE replacements to heavy duty applications to high horsepower applications we offer a complete line of clutches from reputable brand names like South Bend Clutch, Valeo and Luk.

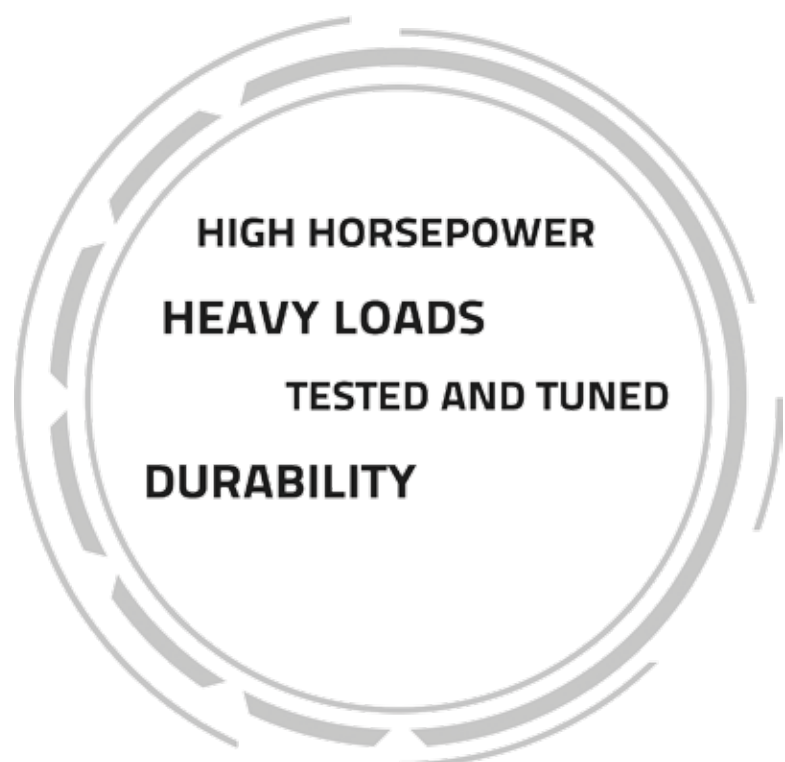

# TORQUE CONVERTERS

Stall torque ratios, one way clutches, single, twin and triples. Confusing, you bet it can be. Here at North American Powertrain Components we understand your requirements and are equipped to assist you and your customers with any of your domestic torque converter needs.

Our in-house 2000 Sq Ft. torque converter shop is staffed with over 30 years of industry experience. Combine this with our state of the art manufacturing equipment and processes, NAPC has the ability to provide you with a quality finished product that is designed and built for your exact application. From daily drivers to 1500+ horsepower competition vehicles, we are here to serve you with all your torque converter needs.



## BALANCING & TESTING

All torque converters undergo a balancing and hydraulic process to ensure that there are no cracks or leaks and all moving parts meet industry standards in precision, integrity and performance alongside with its co-applications.





# NAPC DRIVESHAFT MACHINE CENTER

In December 2012 North American Powertrain Components purchased a driveshaft remanufacturing machine. This piece of equipment was essential to our goal of being the premier bumper to bumper remanufactured powertrain solutions provider. With the addition of this key production equipment, NAPC is truly your one call powertrain supplier.



Whether working on a stock or a custom vehicle application NAPC has the in house ability to custom design, manufacture and supply you with a quality driveshaft assembly that meets your customers exacting needs for work or play. Give our sales team a call and see what NAPC can do for you and your customers.

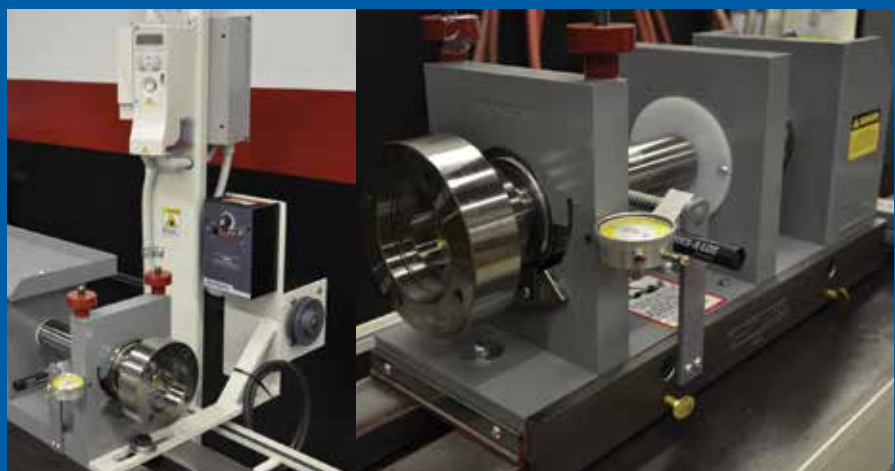

# DRIVE SHAFTS

## ASSEMBLY

All NAPC drive shafts are assembled on our shaft maker using re qualified or new OEM replacement components to ensure conformance to all engineering requirements.

## STRAIGHTENING

All NAPC drive shaft assemblies are checked and straightened on our shaft maker to less than half of industry standards before balancing.



## BALANCING

All NAPC drive shaft assemblies undergo a multiple step RPM balancing process on our shaft maker to ensure a vibration free final product.

## CUSTOMER SATISFACTION

Combining high quality OEM parts with a disciplined remanufacturing process gives NAPC the advantage of supplying you and your customers a superior quality, long life product.

We carry the popular applications for your Dodge, Ford, and GM driveline needs.

## FORD

**5C3Z4A376EF** ..... FRONT - 99-08 F250 & 05-08 F350 1350CV  
**5C3Z4A376DA** ..... 99-08 F250/F350 SRW DIESEL 39 3/8"

## DODGE

**52105932AF** ..... 03-06 W/ MT 19"  
**52105934AC** ..... 03-08 2500/3500 FRONT, 14 5/8 WTW



## GM

**5001719-1623M** ..... SPICER - 1410 SERIES ALUMINUM  
**5001657-1862M** ..... REAR ALUMINUM SINGLE PEICE  
**26022466** ..... FRONT 18" - 26.5" CUP TO CUP  
**DLDRICHE0009** ..... 02-07 GM FRONT 4L60 - 1/2 TON 4X4  
**26038128** ..... FRONT W/ AT (4L80E) 33.5" CHEVY 97-00  
**15902927** ..... FRONT, 2011 GM 1500  
**DLDRICHE0029** ..... FRONT, 2011 GM 3500

All drive shafts undergo a detailed built process by using our in-house remanufacturer driveshaft balancer.



# DOUBLE CARDON CONSTANT VELOCITY JOINTS

From variety to compatibility, we carry not only drive shafts but a large line of constant velocity u-joints for your specified application.

For more information of the individual constant velocity u-joints that we carry, give a call to one of our sales representatives, 1-866-456-4498



## REAR DRIVE SHAFTS

5001657-1862M

CHEV APPLICATION



80 INCHES CENTER to CENTER

5001719-1623M

CHEV APPLICATION



70.75 INCHES CENTER to CENTER

## DRIVESHAFT SUPPORT BEARINGS



If you are looking for a support bearing for your driveshaft, we offer several options in quality and durable hanger bearings for your truck application.

## U-BOLT AND BEARING STRAP ASSEMBLIES



### U-BOLT

Part#	Series
2-94-28X	1210 / 1310 / 1330
2-94-58X	1330 SPECIAL / 3R
3-94-28X	1480 / 1550



### BEARING STRAP

Part#	Series
2-70-18X	1210 / 1310 / 1330
3-70-38X	1480 / 1550
3-70-48X	1350

# UNIVERSAL JOINTS

With high demand, we carry a wide variety of quality grade universal joints from Spicer and American Axle. All universal joints are tested alongside with our yokes to assure that all parts are in working order.



Part#	Series
SPL55-1X	1480/SPL55
SPL55-3X	SPL55 / 1480 WJ
SPL55X	1480/SPL55
5-1204	1330 / FORD
5-1306X	7260
5-1310	1310 / Same as 5-785X
5-1330X	1330/SPL25
5-1350	1350
5-153X	1310/SPL22
5-178X	1350/SPL30
5-188X	1480/SPL55
5-212X	1330/SPL25 x S44
5-213X	1330/SPL25
5-3147	3R
5-3207X	AAM / 1415 DODGE 2500 / 3500
5-7438X	1330

We carry a wide variety of U-joint part numbers other than what we have listed to support the many truck applications to meet our customers high demands, for more details on our full line, call us at 866-456-4498.

5-760X	1310 (Wheel Joint)
5-789X	7260
5-793X	1330/SPL25 x S44
5-795X	S44
5-811X	7290



Part#	Series
12479126	1344
19256728	1355
74085339	1415
74081485	1485
74081555	1555



# 4X4 YOKES



All 4X4 yokes are supplied from our trusted line of suppliers; American Axle and Spicer. We also carry additional yokes that are not listed, for details on our full line, call us at 866-456-4498.

## SOCKET



211913X	1330
211631X	1330
211545X	call for specifications
211543X	1310
211355X	1310
212019X	1350

## SLIP



40038575	1344 3R 32 Spline
40036532	1415 / 1410 32 Spline
40038559	1415 / 1410 36 Spline
40041575	ASM 34 Spline
40038537	1415 / 1410 w/Damper
40039594	1480 / 1485 31 Spline
40038344	1355 32 Spline
40110100	Trans. 1415 / 1410 31 Spline
40032054	3R - S44 32 Spline

## WELD



40038510	1485 / 1480
40019009	1415 / 1410
40018761	1415 Aluminum
26050910	1344 2.75 x .065
40021575	1480 / 1485 Aluminum
40070855	call for specifications
40038509	1415 / 1410

## FLANGE



40022500	1415 / 410
40055528	1485 / 1480
40038359	Serrated

## BALL STUD



3-281527X	1350
2-28-3447X	1330
2-28-2827X	1310
2-28-3067X	1330
3-28-1327X	1350

## STUB



40038577	32 Spline
40038581	36 Spline
40043585	2" Tube Style 3
40048387	2" Tube Style 1

## END



40047860	C9.25 -Serrated
40017655	6m 7.6
26060884	1410 Yoke & Strap Kit



3-4-11081-1X	1410
--------------	------

# ENGINES

North American Powertrain Components would like to introduce our new line of engines. We stock brand new gas and diesel and reman engines. The following are some of our applications. If not listed, please phone for availability and pricing.



## FORD

7.3L	.....	99-03 7.3L POWERSTROKE LONG BLOCK
7.3L with Tin	.....	99-03 7.3L LONG BLOCK w/Tin
5.4L	.....	04 F150 5.4L LONG BLOCK GAS 3 VALVE
6.4L	.....	6.4L SUPER DUTY COMPLETE DROP-IN
6.0L	.....	03-07 6.0L LONG BLOCK AUTOMATIC

## DODGE

5.9L STD.TRAN	.....	05-07 5.9L LONG BLOCK - G56 STD DUAL MASS
5.9L AUTO-TRAN	.....	03-04.5 5.9L LONG BLOCK 325HP CUMMINS
5.9L AUTO.TRAN	.....	05-07 5.9L LONG BLOCK AUTOMATIC
6.7L	.....	2011 CAB CHASSIS FULLY DRESSED LONG BLOCK COMPLETE

## GM

6.5L	.....	95-01 6.5L LONG BLOCK
------	-------	-----------------------



# SHIPPING WORLDWIDE

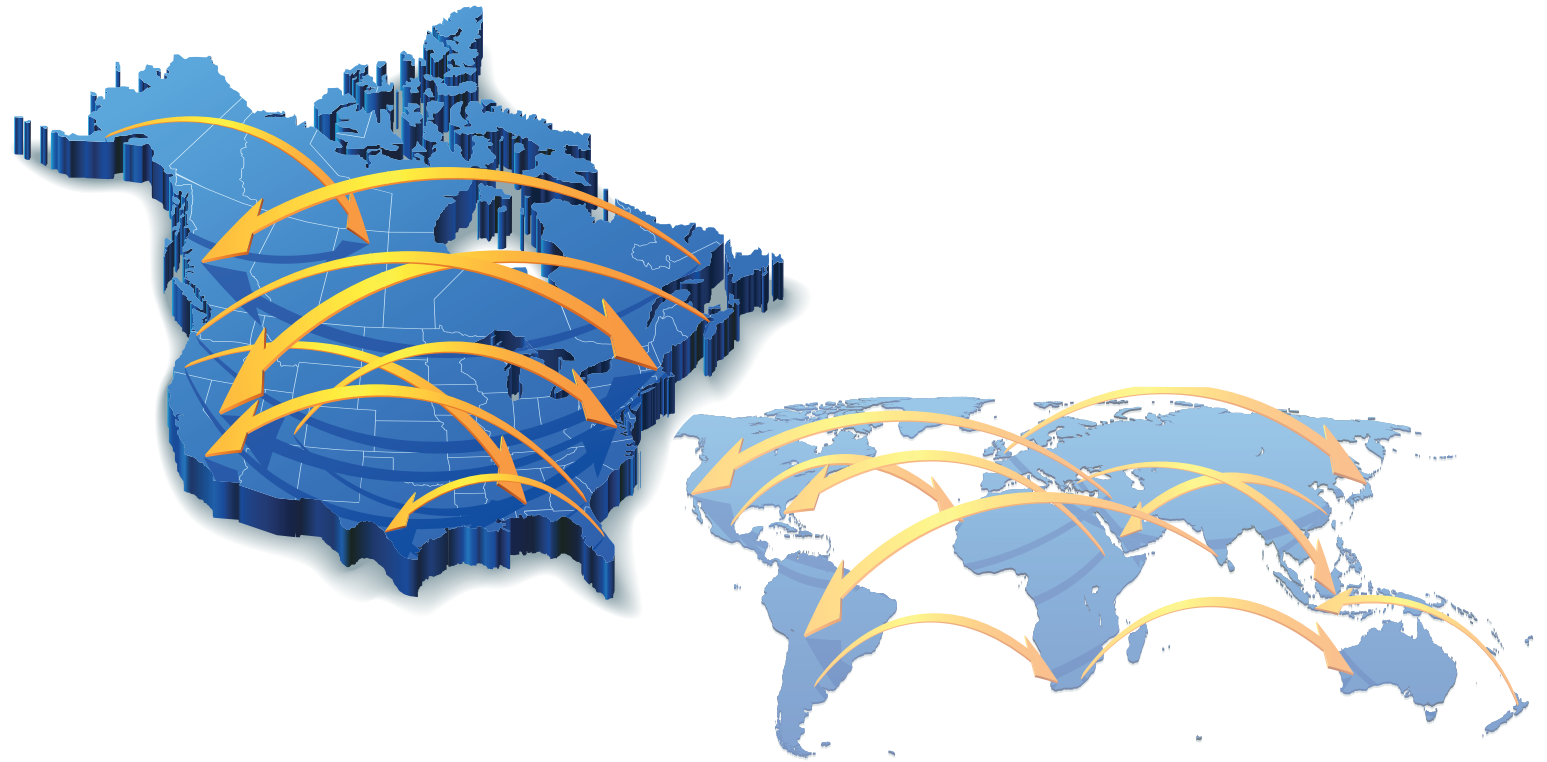

**ALL UNITS AND PARTS ARE SHIPPED SECURELY WORLDWIDE**

Rest assured that all transmissions and transfer cases are safely shipped out to our customers by placing your quality product into our customized shipping case. This provides durability, convenience and assurance to wherever your shipment needs to be.



# QUESTIONS TO ASK WHEN SPECING A UNIT

We offer a comprehensive support line to ensure that our customers are guided in the correct direction. If you have any questions regarding replacing, upgrading, or service options for your powertrain components, please refer to the below guidelines for information that will be viable to you upon calling in to discuss with one of our representatives.

## TRANSMISSION

---

- YEAR
- MAKE
- MODEL
- ENGINE SIZE
- 4X4, 2 OR ALL WHEEL DRIVE

## TRANSFER CASE

---

- YEAR
- MAKE
- MODEL
- ENGINE SIZE
- ASSEMBLY NUMBER TAG
- GAS OR DIESEL

## DIFFERENTIAL

---

- YEAR
- MAKE
- MODEL
- POSI TYPE
- RATIO
- SINGLE OR DUALY

To contact one of our sales representatives, please call 866.456.4498 or you can also email us at [info@napc.ca](mailto:info@napc.ca).



# GET IT NOW IN CANADA!

## NORTH AMERICAN POWERTRAIN COMPONENTS



CANADA'S SOURCE FOR  
**HONDA**  
**TRANSMISSIONS**

**CALL 1.866.456.4498**

We are proud to announce the launch of H&A Gearspeed, the premier line of Honda transmissions in the world. H&A has put together the most prolific build process of Honda transmissions in the industry. This build process is second to none and is now available to Canadians.

Recognizing a growing problem of the vast number of Honda & Acura units needing case replacement, NAPC now offer remanufactured cases. The cases are bored out in the problem bearing areas and sleeved to bring them back to OEM specs. This process establishes what is known as the "true geometric" anchor point, allowing all shafts to run true and completely eliminating any whine. Through our R&D department we have also established any longevity concerns with our state of the art bonding process.



## BUILD PROCESS

**EACH TRANSMISSION IS BUILT FROM START TO FINISH:**

- 1 First, the transmission is broken down, cleaned and inspected by our tear down department.
- 2 The valve bodies are placed in an ultra-sonic cleaning station after the builder tears them done and inspects all springs and pistons.
- 3 Valve bodies are then re-assembled by the builder, who then goes over the notes of both prior inspections.
- 4 Each transmission goes through four cleaning stages and four inspection stages to insure cleanliness and quality parts.
- 5 Lastly, each transmission is built and tested using the finest OEM hard parts and bearings to ensure a unit that will last for many years.

**3YR** HONDA & ACURA UNITS NOW IN STOCK!  
**100K** 3 yr/100,000KM Warranty





DODGE 5500 CAB & CHASSIS

**GET WHAT YOU NEED TODAY!**  
**CALL 866.456.4498**

FRONT DRIVE SHAFT - 19" OR 22"



G5600 MANUAL TRANSMISSION



A568RC/ A569RC  
AUTOMATIC TRANSMISSION



DANA 5111 REAR DIFFERENTIAL



FRONT DIFFERENTIAL - MAGNA STEYR  
RA720 - 4.88/4.44



FAG WHEEL HUBS  
OEM QUALITY WHEEL  
BEARINGS



TRANSFER CASE  
273D OR 271D CAB & CHASSIS



info@napc.ca | NAPC.CA | 866-456-4498



DODGE 5500 CAB & CHASSIS

# HAVE QUESTIONS? WANT TO ORDER?

## TORQUE TECH HANDHELD TUNER

*Touch screen display to monitor and maximize your truck's performance*



CALL

**866.456.4498**



## S&B INTAKE

*Increase air flow and maximize power.*



## EGR DELETE

*Increase durability & lower coolant temps*



## EFI BY RYAN CUMMINS AUTOCAL

*Bullydog - EFI Live  
13-15 Dodge Cummins*



## DPF DELETE PIPES

*Increase fuel economy*

# NADP

info@nadp.ca | [NADP.CA](http://NADP.CA) | 866-456-4498



***ENGINEERED BEYOND THE GEARS™***